

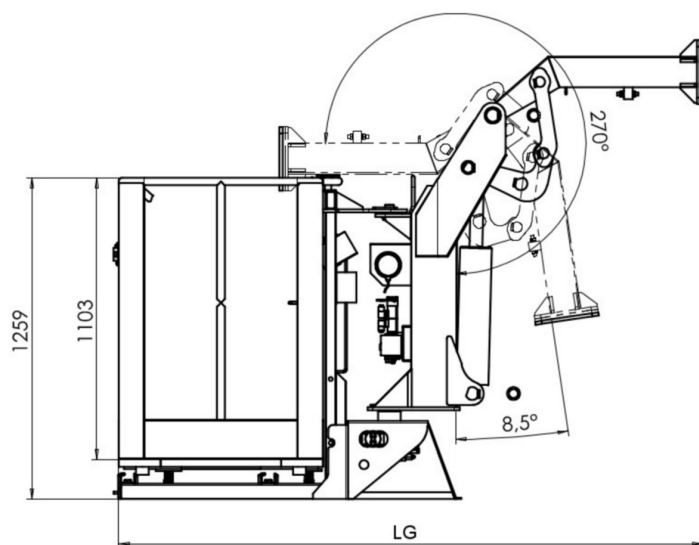

AL 300/20

Piattaforma autolivellante Idraulica



SELF-LEVELING PLATFORM | AUTOMATISCHE HEBEPLATTFORM | PLATAFORMA AUTONIVELANTE
PLATE-FORME AUTONIVELÉ | САМОВЫРАВНИВАЮЩАЯ ПЛАТФОРМА

	Kg	370
	Kg	300
	N°	3
L	mm	2149
LG	mm	2366
P	mm	877
Rotazione piattaforma	gradi	±90°
Brandeggio piattaforma	gradi	170° (265°)
Tensione impianto elettrico	V	24
Portata consigliata impianto oleodinamico	L/min	12
Pressione massima impianto oleodinamico	bar	190

